

Manual



Contents

Attention	1
Accessories	1
1.Introduction	
1.1 DVR	2
1.2 DVR slot	2
1.3 Panel	3
2. IR remote control	3
3. Insert the SD card	4
4. AV cables, power cable connection	4
5. Screen icons instruction	5
6. Setting	
6.1 Operating DVR with IR remote control	6
6.2 Image setting	7
6.3 Recording setting	9
6.4 Recording mode setting	15
6.5 Playback and delete video files	16
6.6 System setting	18
7. F. A. Q.	21

Attention!

1. Don't take SD card out when DVR is working
2. Use original power cable and AV cables
3. Format SD card by DVR system on your first use
4. Install the unit in dry and ventilatory environment
5. Use genuine SD card
6. Warranty and free maintenance will be invalidated if you disassemble the unit

Description

Welcome to use our product!

This DVR unit is designed for in-vehicle security surveillance, with IR remote to control the unit; SD CARD for data storage is shockproof on vehicles and enables easy playback.

Accessories



Remote control



Power cable

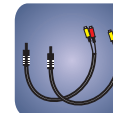

AV cable

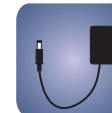

Power adapter



Manual

1. Introduction

1.1 DVR

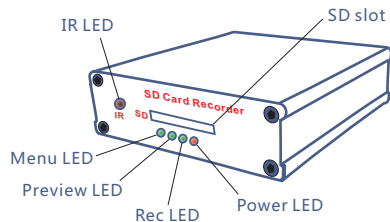

1.2 DVR slot

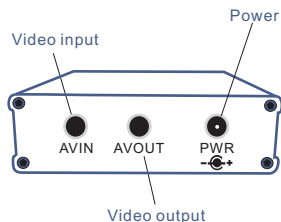

1.3 Panel

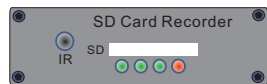

IR	IR led for remote control
SD	SD card slot, 32GB max.
1st Green Led(from left)	menu led, constant on when in menu mode; blinks when in playback mode
2nd Green Led	review led, constant on when in review mode; blinks when reading SD card
3rd Green Led	record led, blinks when recording
4th Green Led	power led, blinks when working



AVIN	video input
AVOUT	video output
PWR	power plug-in(5-30V)

2. IR remote control



Buttons	Functions
▲	Up/volume up(during playback)
▼	Down/volume down(during playback)
◀	Left/fast backward(during playback)
▶	Right/fast forward(during playback)
OK	Set/record(during playback)
MENU	Menu
P/P	Play/pause/delete files
STOP	Stop
ESC	Return to last menu/playback

3. Insert the SD card

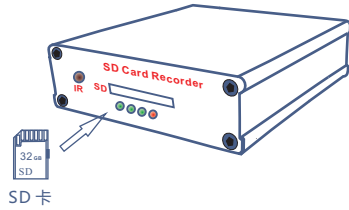

4. AV cables, power cable connection

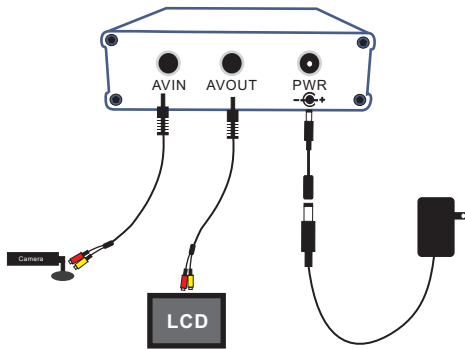

Note: please connect all cables correctly, in case of system failure.

5. Screen icons instruction

5.1 Standby mode

*The following pictures are for references only

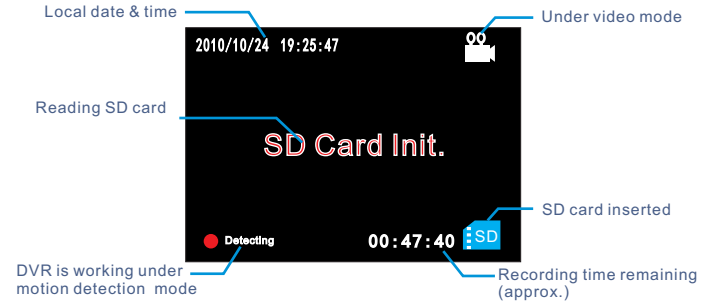

5.2 Recording mode

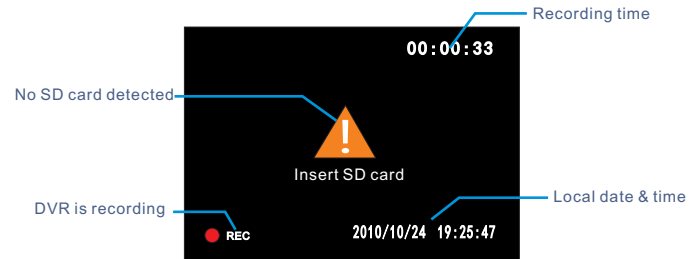

6. Set up

* You need to connect the DVR with TV or monitor before set-up

6.1 Operating DVR with IR remote control



Buttons	Functions
▲	Up/volume up(during playback)
▼	Down/volume down(during playback)
◀	Left/fast backward(during playback)
▶	Right/fast forward(during playback)
OK	Set/record(during playback)
MENU	Menu
P/P	Play/pause/delete files
STOP	Stop
ESC	Return to last menu/playback

Main operations:

Enter into system menu: press “MENU” on remote

Choose items to set up: press direction keys

Confirm your choice: press “OK”

Return to last menu: press “ESC”

6.2 Image setting

6.2.1 Image quality

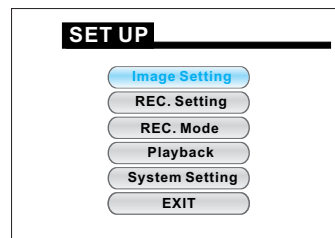

A. press “MENU” key to enter into system SET-UP.

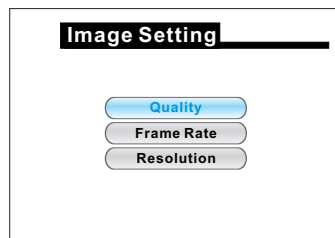

B. press “OK” to set

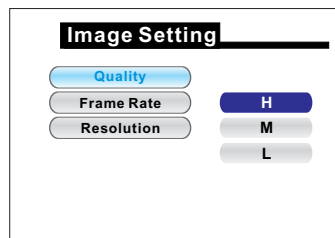

H: best image quality

M: normal image quality

L: low image quality

* the lower the image quality, the longer the recording time

6.2.2 Video frame rate

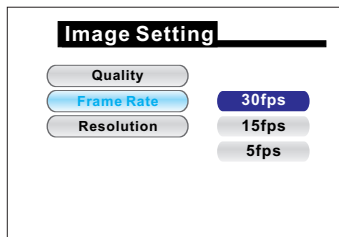

30fps: smooth image

15fps: not so smooth image

5fps: jerky image

*the lower the frame rate, the longer the recording time

6.2.3 Image resolution

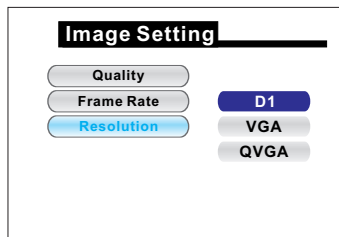

D1: 704X576

VGA: 640X576

QVGA: 320X288

*the lower the resolution, the longer the recording time

6.3 Recording setting

6.3.1 Scheduled time

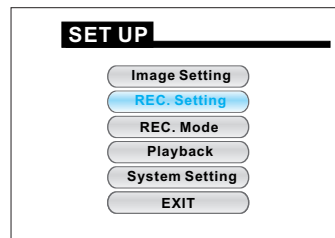

A. press "MENU" key to enter into system SET-UP.

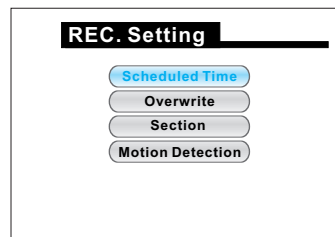

B. system starts and stops recording automatically according to the scheduled time period

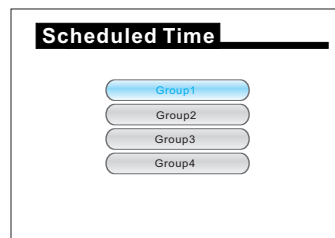

C. press "OK" for 4 groups
press UP/DOWN to choose
press "OK" to enter into each group

*Weekly

Weekly	Once	Off
Start Time	: 07 : 00	
End Time	: 13 : 00	
SUN	MON	TUE
WED	THU	FRI
SAT		

A. press LEFT/RIGHT to choose modes:

Weekly: auto record weekly
 Once: auto record once
 Off: switch off this group

B. e.g. to choose "Weekly" mode, press UP/DOWN, "Weekly" mode is confirmed when it's in blue; press "OK" to the next step, select Start Time & End Time

Weekly	Once	Off
Start Time	: 07 : 00	
End Time	: 13 : 00	
SUN	MON	TUE
WED	THU	FRI
SAT		

C. press UP/DOWN to change time; and RIGHT to move on and select days that is needed

Weekly	Once	Off
Start Time	: 07 : 00	
End Time	: 13 : 00	
SUN	MON	TUE
WED	THU	FRI
SAT		

D. e.g. to choose MON, press UP/DOWN to select/dis-select it;

refer to the picture on the left, MON-FRI are all selected

Note: purple font means selected, black font means dis-selected

E. press "OK" to finish weekly set-up, the 2 yellow triangle will go back onto "Weekly" (in blue)

F. press "ESC" to save and return to group list for other groups set-up

*Once(Daily)

Weekly	Once	Off
Start Time	: 2011/01/01 07 : 00	
End Time	: 2011/01/01 13 : 00	

A. choose "Once", press UP/DOWN, "Once" mode is confirmed when it's in blue

B. press "OK" to move on, please refer to "Weekly" set-up

*Off

Weekly	Once	Off
--------	------	-----

A. choose "off", press UP/DOWN, the group is switched off when it's in blue

B. press "ESC" to switch off this group

Note:

A. in each group, only one mode can be selected among "Weekly", "Once" and "Off";

B. if scheduled period in "Weekly" overlaps with those in "Once", system will auto choose to record under the longer period; the same method applies to overlaps in between different groups;

C. press UP/DOWN to select each mode in a group, blue font means mode selected;

6.3.2 Overwrite

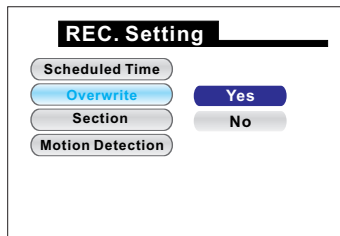

A. system will delete the first 300MB files once the SD card is full to save new files

6.3.3 Section recording time set up

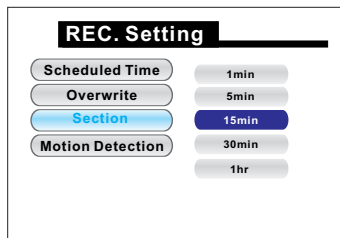

B. set up section recording time

* only available under "Manual", "Scheduled" and "Power Up Rec." modes

*2.5 min section recording time is fixed under "Motion Detection" mode

6.3.4 Motion detection

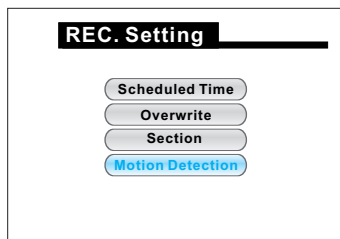

C. set motion detection details

6.3.4.1 Mask Area

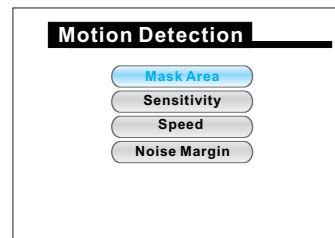

A. enter into "Mask Area", the screen will be shown in grids as below:

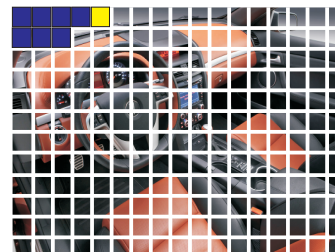

B. press direction keys to move the cursor to choose the area needn't be detected

C. press "OK" to confirm blue grids area won't be motion-detected

D. all grids area that the camera covers are recorded in image

6.3.4.2 Sensitivity

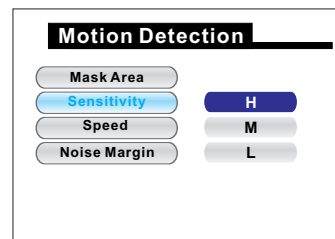

H: high level
M: middle level
L: low level

* system will be triggered very easily if sensitivity is set under high level.

6.3.4.3 Speed

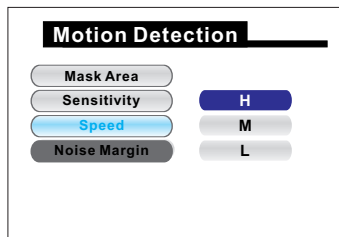

A. different speed levels to trigger system

*system will be triggered very easily if speed is set in low level.

6.3.4.4 Noise Margin

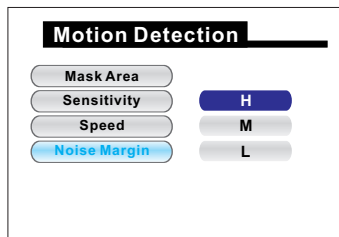

B. different noise levels to trigger system

*system will be triggered very easily if noise is set in low level

6.4 Recording mode set up

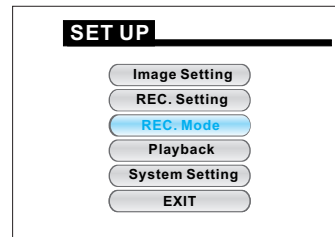

set the recording mode for system

6.4.1 Recording modes

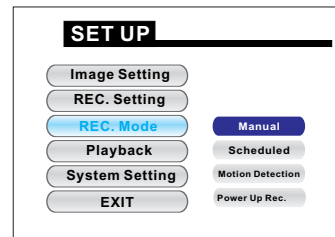

choose a mode first:

Manual:
under this mode, press "OK" to start recording, and "STOP" to stop recording

Scheduled:
system starts and stops recording according to the scheduled period preset

Motion Detection:
system starts recording automatically by detecting motions in the area preset;
*2.5min section recording time is fixed

Power Up Rec.:
system starts to record as soon as the power is on

6.5 Playback and delete video files

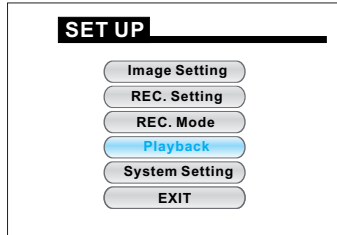

A. press "OK" to enter into file list

6.5.1 Under file list mode

File Name	Date	Start Time
00000001	2010/10/24	06:57:54
00000002	2010/10/24	08:11:31
00000003	2010/10/24	13:53:24
00000004	2010/10/25	07:27:05
00000005	2010/10/25	07:28:35
00000006	2010/10/25	08:11:04
00000007	2010/10/26	22:55:14
00000008	2010/10/26	22:56:54

Page 01/14

Delete:

A. press UP/DOWN to choose the file(s) you want to delete

B. press "P/P" or "DEL." to delete

Play:

A. press UP/DOWN to choose and "OK" to open the file

B. press "P/P" to play

Fast forward/backward:

Press RIGHT/LEFT to fast forward/backward, one press increases play speed rate (can choose 2,4,8,16 rates).

Volume up and down

Press UP/DOWN to turn volume up/down. Highest volume level is 8.

Pause:

Press "P/P" to pause, press it again to start.

Stop:

Press "STOP" to stop playing.

Exit playing mode:

Press "ESC" to return to file list.

6.5.2 Playback video files on computer

*playback via Media Player

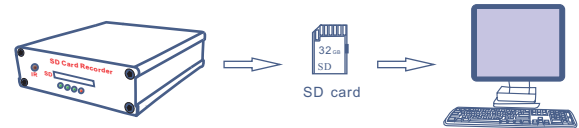

6.5.3 Icons instructions under playback mode

A. Playback on TV set or monitor



B. Playback on computer

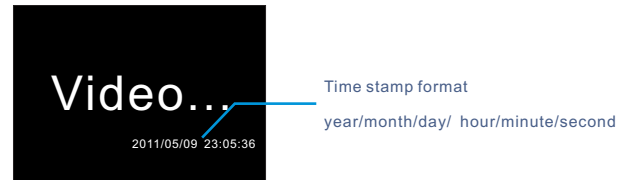

6.6 System Setting

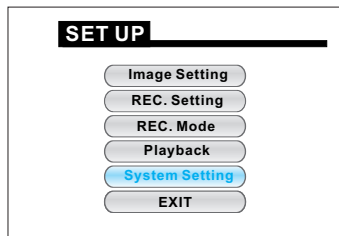

*system set-up

6.6.1 Language

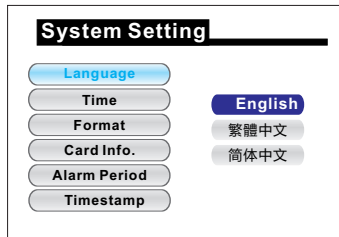

*choose your language

6.6.2 Date and time

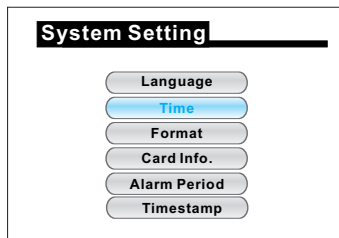

*set local date & time

6.6.2.1 Date and time

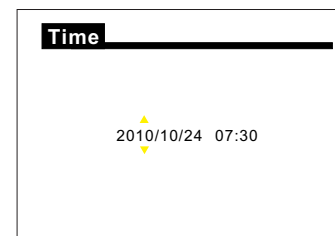

*press LEFT/RIGHT to move the cursor

*press UP/DOWN to adjust the values

*press "OK" to save the setting

6.6.3 Format

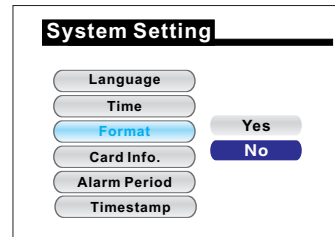

*choose "Yes" to format SD card

Attention!

all files can not be restored after being formatted from SD card

6.6.4 Memory card information

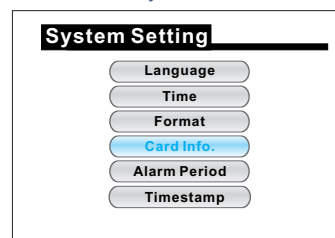

*check SD memory capacity

6.6.4 Memory card information

Card Info	
Total Size	: 30784MB
Used Size	: 98.6%
Remain Size	: 1.4%

*check card memory

*press "ESC" to exit

6.6.5 Alarm Period

System Setting	
Language	
Time	Always OFF
Format	10Sec
Card Info.	20Sec
Alarm Period	30Sec
Timestamp	

* choose alarm ON/OFF, and length

* system outputs a 12V voltage for external alarm devices when motion detection is triggered

6.6.6 Time Stamp

System Setting	
Language	
Time	
Format	
Card Info.	YES
Alarm Period	NO
Timestamp	

* choose Timestamp ON/OFF

7. F.A.Q.

Q: DVR can not read SD card.

A: Please use 1GB to 32GB genuine SD card.

Q: No images on TV after turn on the DVR.

A: Please check the cable is correctly connected. Yellow connector should connect with video input port on TV.

Q: No sounds when playing video.

A: Please check the cable is correctly connected. Red connector should connect with audio input port on TV.

B: The camera connected with DVR should be with audio feature.

Q: No recorded files in SD card after system records.

A: 1. Please check if the SD card works with DVR normally;
2. Please use 1GB to 32GB genuine SD card.

Q: DVR system crashes when it is on.

A: 1. You can not take out or insert SD card when it is on;
2. Please make sure it is a genuine SD card.

Q: DVR doesn't record video when motion detected.

A: 1. Please set "Recording mode" to "Motion Detection"
2. Set "Sensitivity", "Speed" and "Noise Margin" according to the suggestions on page 13-14.

Q: Remote control is not working.

A: 1. Check whether remote battery is flat: connect DVR with camera and monitor, press any buttons on remote, with remote LED facing the camera to see whether there is a spark in the monitor; if not, please replace a new battery;
2. Remote control only works in open space.